

- ▶ **High quality micro switches for a wide range of applications**
- ▶ **Excellent performance, high reliability and long service life**
- ▶ **UL/cUL and ENEC certification**
- ▶ **Applications - Telephone, Air conditioner, Computer, Humidifier, Alarm, Time recorder, Mixer & Chopper, Solder gun, Neon phone, Fax machine, Joystick, Water pump, Gas detector, Pencil sharpener, Money sorter, Food processor, Electric knife, Toy car, Juice maker, Electric steak pan.**

Certification information

Model name	UL - cUL	ENEC
SW2-C1	0.1RA 125/250VAC uT125 1E4	0.1A 125/250VAC uT125 1E4
SW2-C3	3GPA 125/250VAC uT125 1E4	3A 125/250VAC uT125 1E4
SW2-06	5RA 30VDC uT125 1E4 6GPA 125/250VAC uT125 1E4	5A 30VDC uT125 1E4 6A 125/250VAC uT125 1E4
SW2-10	5RA 30VDC uT125 1E4 10RA 125/250VAC uT125 1E4 10GPA 125/250VAC uT125 1E4	5A 30VDC uT125 1E4 10(2)A 125/250VAC uT125 1E4
SW2-H10	5RA 30VDC uT125 1E4 10RA 125/250VAC uT125 1E4 10GPA 125/250VAC uT125 1E4 1/4HP 125/250VAC uT125 1E4	5A 30VDC uT125 1E4 10(2)A 125/250VAC uT125 1E4

Selection of rating & force

MODEL	Rating	L	S	H
SW2	0.1A	★	★	★
	3A	★	★	★
	6A	★	★	★
	10A 10(2)A		★	★
	1/4 hp 10A 10(2)A		★	★

NOTE: The symbol " ★ " represents the result is accepted



Dimensions

Unless otherwise specified, a tolerance of $\pm 0.4\text{mm}$ applies to all dimensions.

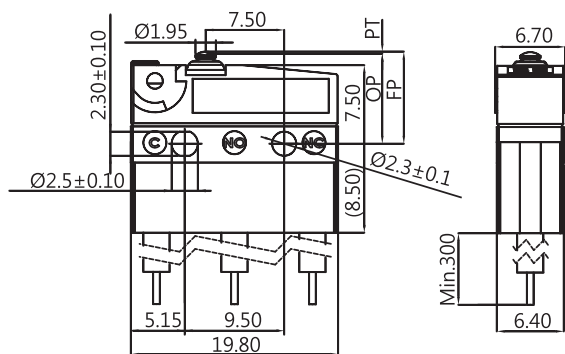



Ordering information

(Please use the characters in the chart below to create your product code)

Sample code SW2 - 06 S 1 - 00 0 0 E A





Rating Current

C1	0.1A 125/250VAC
C3	3A 125/250VAC
06	6A 125/250VAC
10	10A 125/250VAC 10(2)A 125/250VAC
H10	10A 125/250VAC 10(2)A 125/250VAC 1/4hp 125/250VAC

Operating Force

H	Heavier
S	Standard
L	Light

Actuator Type

00	
01	
02	
03	

Wire Side

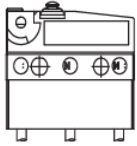
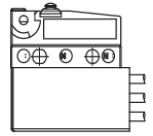
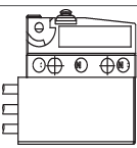
O	
R	
L	



Sample code SW2 - 06 S 1 - 00 0 0 E A

Circuit Arrangement

0	S.P.D.T.
1	S.P.S.T. NO
2	S.P.S.T. NC

AWG Type

E	20
F	22
G	24
H	26

UL Number

A	UL1007
B	UL1015
C	ELI430
D	UL1061
F	AV

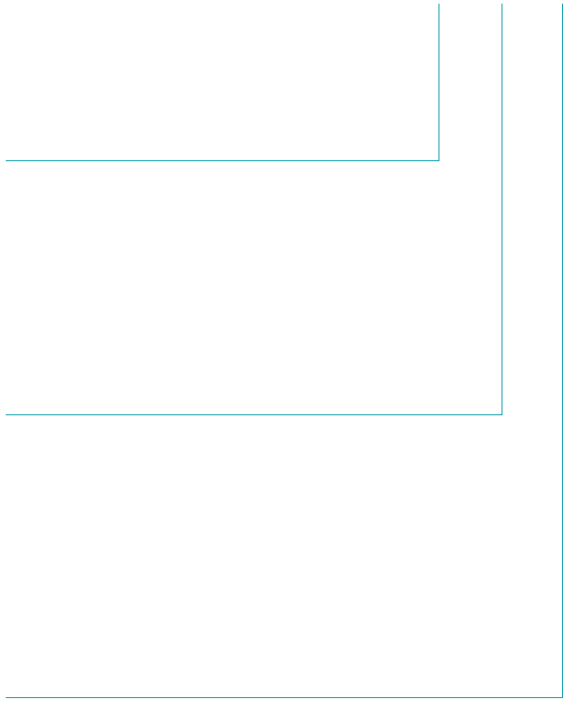

Rating Current	AWG Type	Leads Wire	Operating Force
C1	20, 22, 24, 26	Min. 30cm	L, S, H
C3	20, 22, 24, 26	Min. 30cm	L, S, H
06	20, 22	Min. 30cm	L, S, H
10	20	Min. 30cm	S, H
H10	20	Min. 30cm	S, H
UL number code : F.AV wire (no safety)			

If you require a customized solution for your program contact our sales team.