

Connectors and Cable Assemblies

AI-Tek stocks a selection of connectors and cable assemblies for your convenience. For ease of selection, the connectors and assemblies are divided into groups. Group "A" is designed for 2-wire items, Group "B" for 3-wire and Group "C" for 5-wire.

Complete cable assemblies include the connector and 10' of recommended wiring for use with AI-Tek equipment. All wiring is insulated, and wrapped with braided or copper shield and jacketed in long-lasting PVC, Teflon or polyolefin insulation. Alternate cable length is 50', use -050 for final suffix.

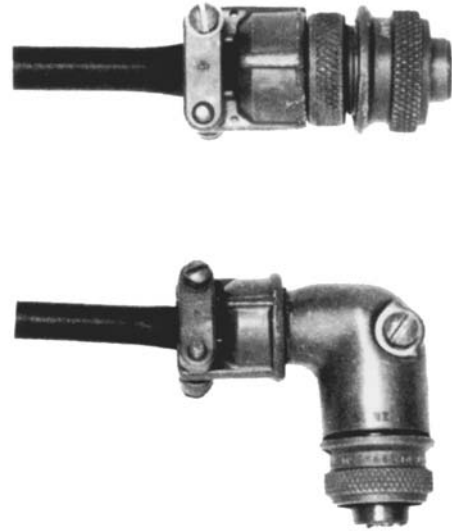

Group		A-I Tek P/N	Mil. Connect. No.	Max. Temp.	Cable Wiring
A	S	CN79860 -3100	MS3106A10SL-4S	125°C	Connector Only
	R	-3800	MS3108B10SL-4S	125°C	Connector Only
	S	-3000	MS3456L10SL-4S	175°C	Connector Only
	S	CA79860 -01-010	MS3106A10SL-4S	105°C	2 #22 Black & White
	R	-17-010	MS3108B10SL-4S	105°C	2 #22 Black & White
	S	-06-010	MS3456L10SL-4S	175°C	2 #20 Black & White
B	S	CN79860 -2600	MS3106A10SL-3S	125°C	Connector Only
	R	-3900	MS3108B10SL-3S	125°C	Connector Only
	S	CA79860 -18-010	MS3106A10SL-3S	125°C	3 #20 Red, White & Black
	R	-24-010	MS3108B10SL-3S	125°C	3 #20 Red, White & Black
C	S	CN79860 -4200	MIL-C-26482	125°C	Connector Only
	S	CA79860-30-010	PT06W-10-6S Bayonet Style	125°C	5#22 Red, Orange, Black, White, Green

Net Weight: 5 oz. max.

Standard cable assemblies include 10ft. of shielded cable. Special length cables may be available for 50 pcs or more.

S = Straight Connector
R = Right Angle Connector

It is the customer's responsibility to determine whether the product is proper for customer's use and application.

Groups A & B (Straight)

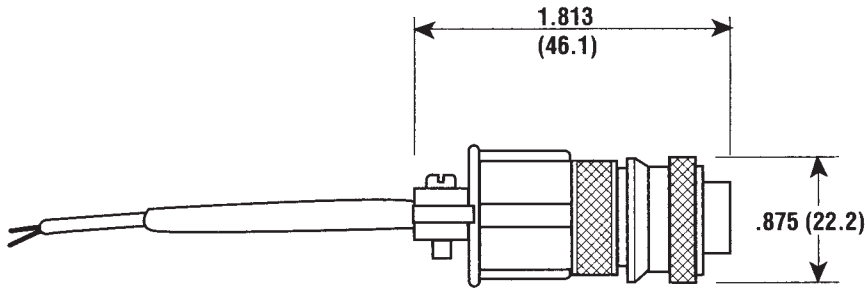

Group A Pins

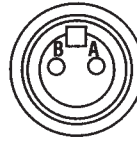

Group A
 PIN A = Black
 PIN B = White

Groups A & B (Right Angle)

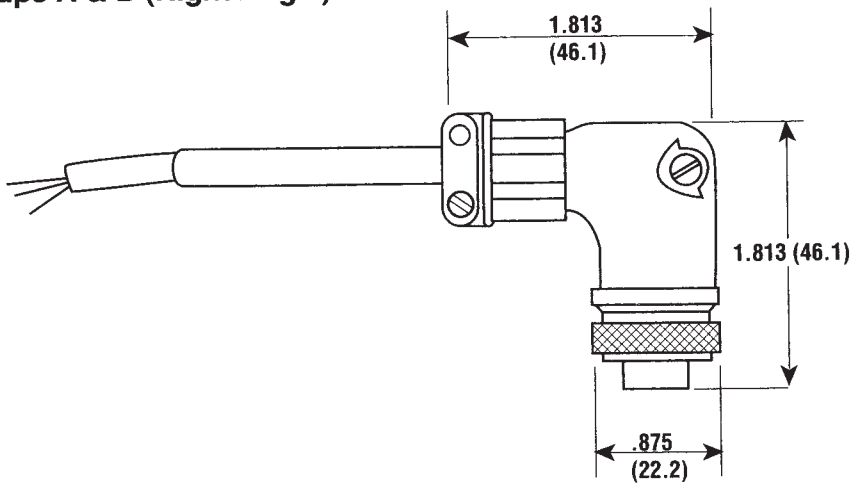

Group B Pins

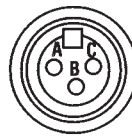

Group B
 PIN A = Red
 PIN B = White
 PIN C = Black

Group C

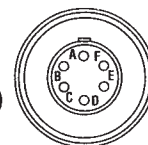
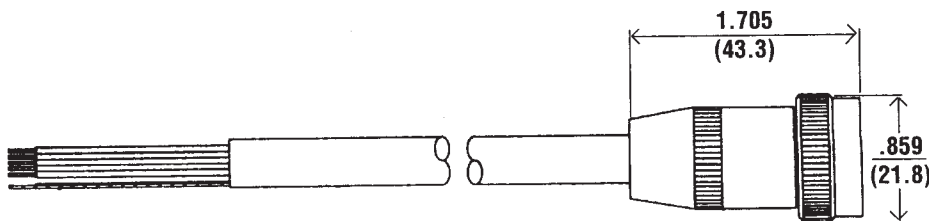

Group C
 PIN A = White
 PIN B = Not Used
 PIN C = Orange
 PIN D = Green
 PIN E = Red
 PIN F = Black